

# LA POTATURA DELLA VITE

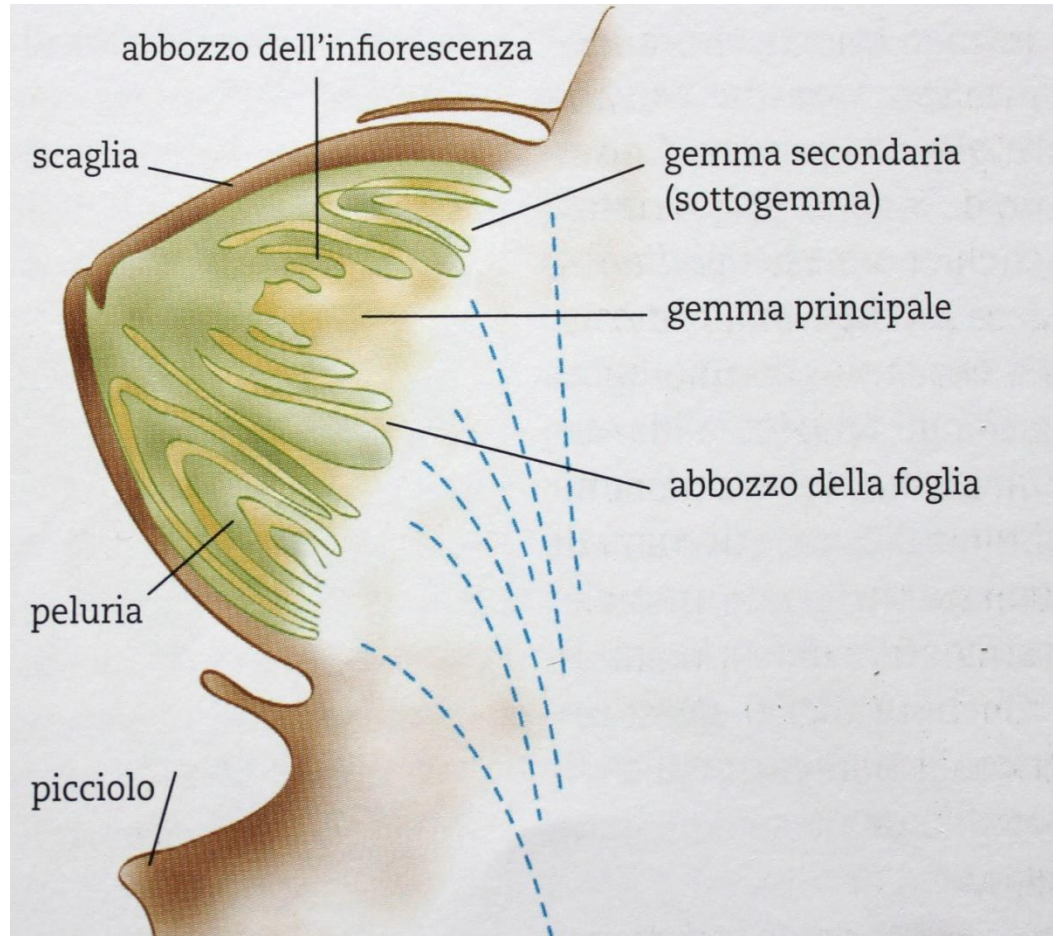

# LA GEMMA



# EVOLUZIONE DELLA GEMMA

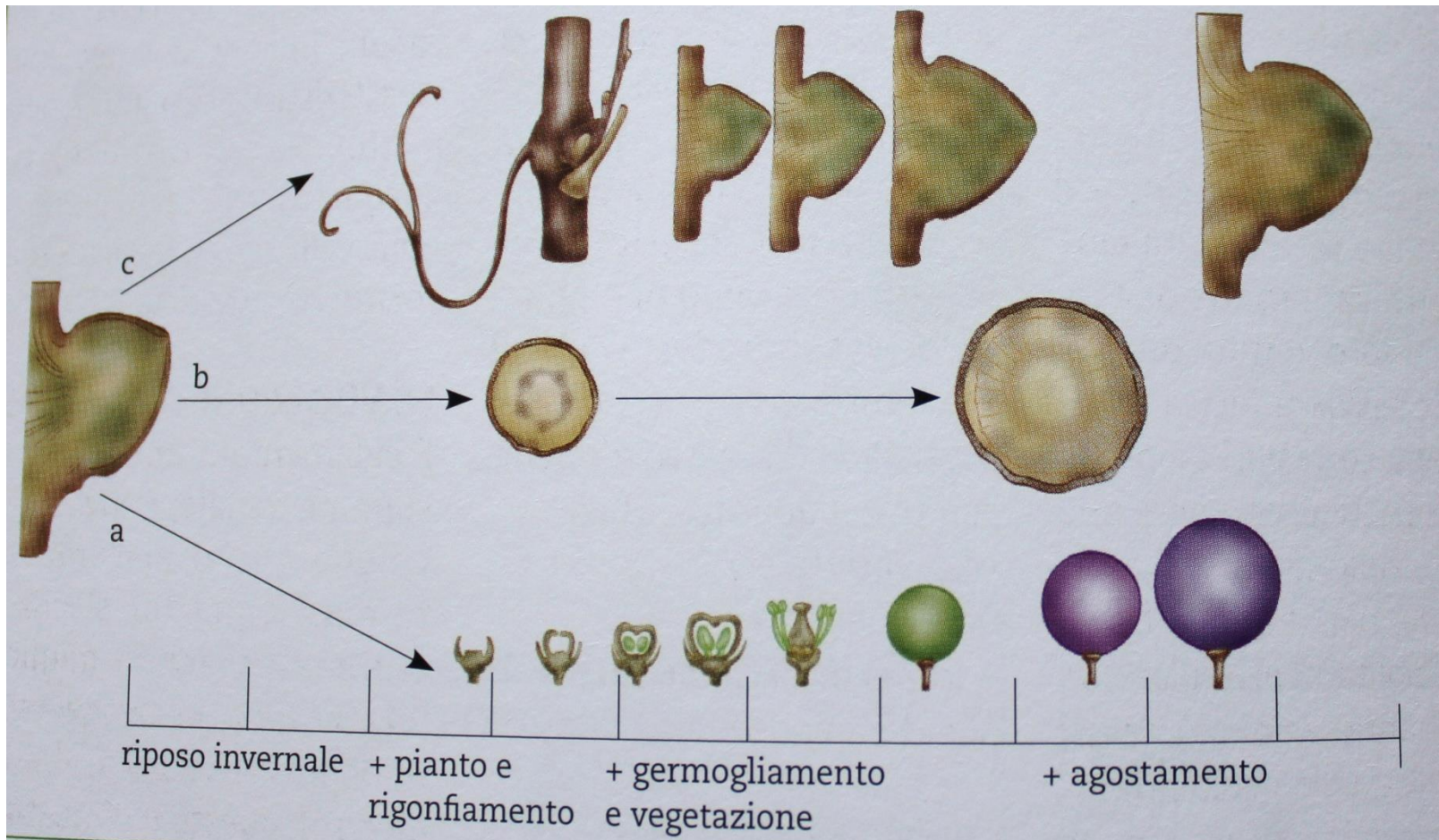



# IL FIORE E LA FOGLIA

## TIPI DI FIORE DELLA VITE



## IL RUOLO DELLA FOGLIA

la foglia è un captatore di energia solare

equilibrio foglie/produzione

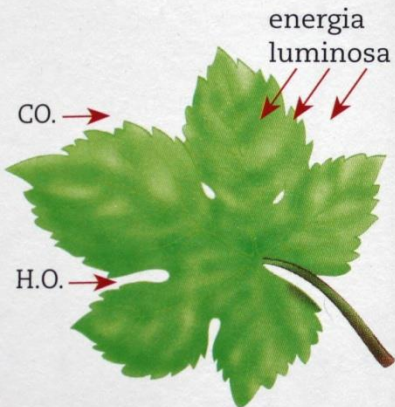

per la maturazione di 1 kg di uva è necessario 1 m<sup>2</sup> di foglia funzionante



zuccheri  
- maturazione  
- agostamento  
- riserve



# L'ACINO

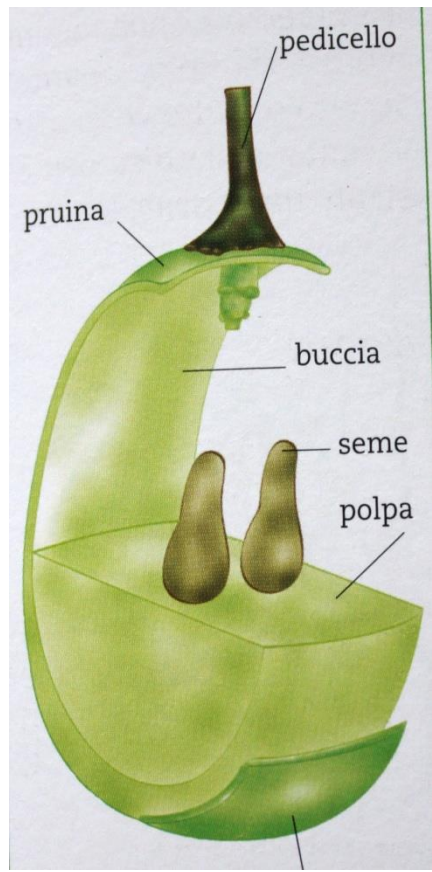
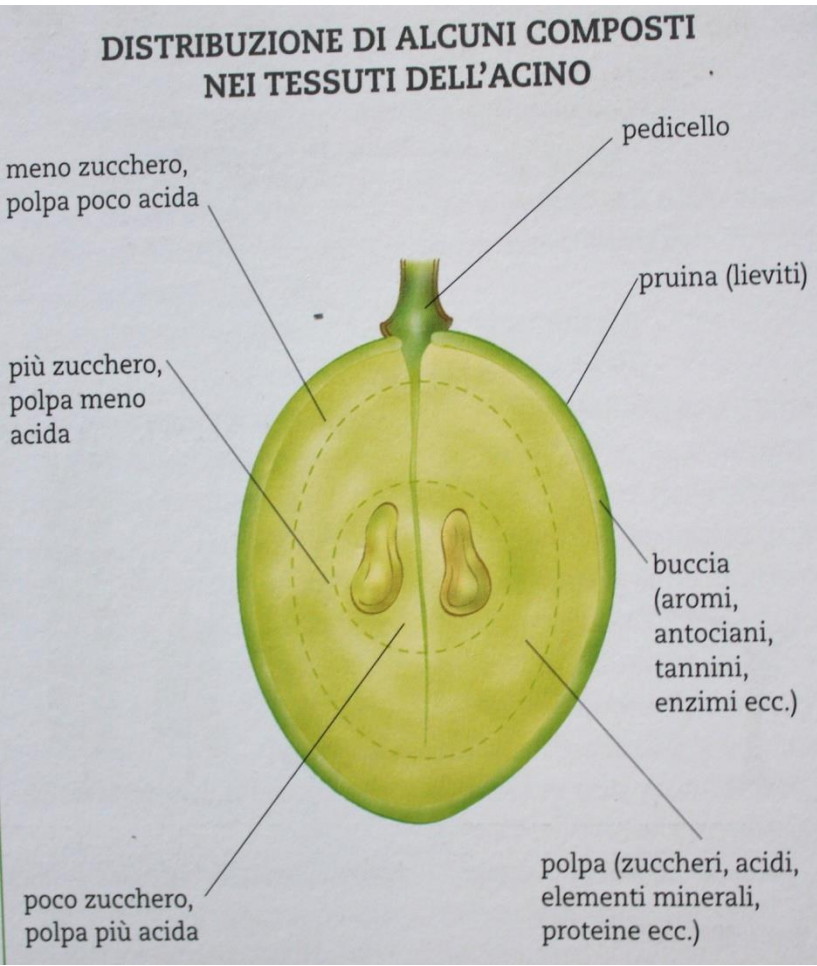

# FORMA DEGLI ACINI

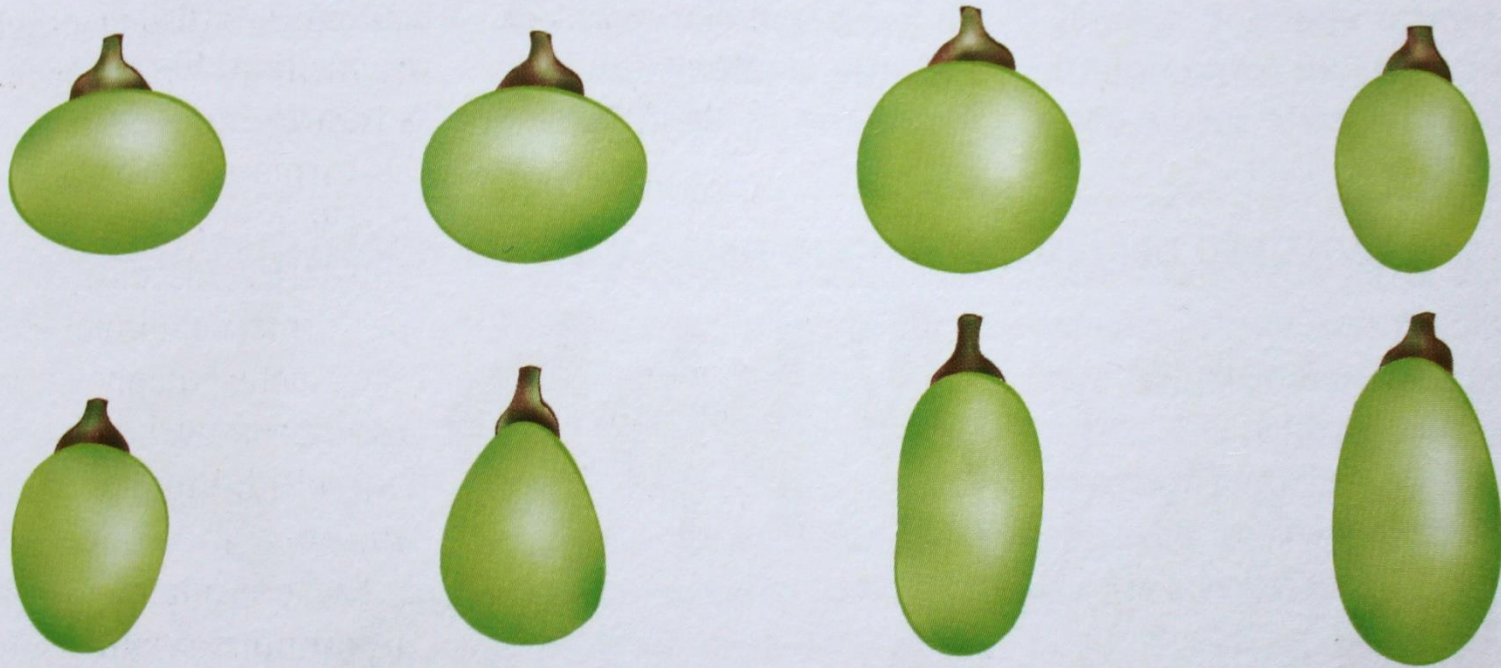

La forma degli acini (così come quella dei grappoli) è variabile

# LA FECONDAZIONE

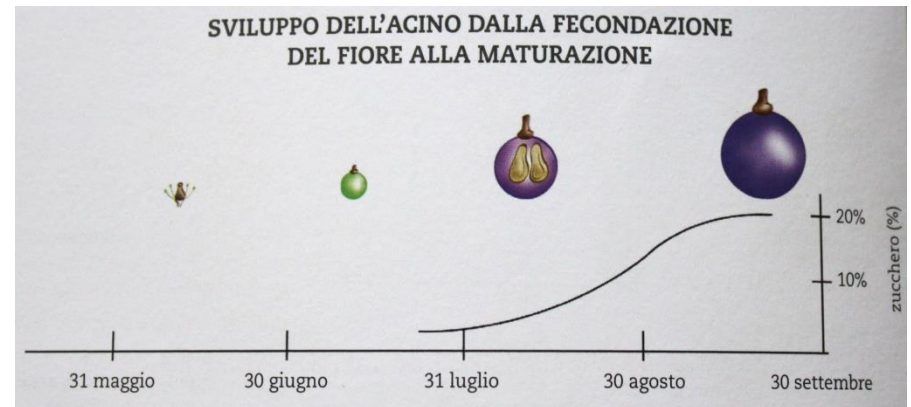
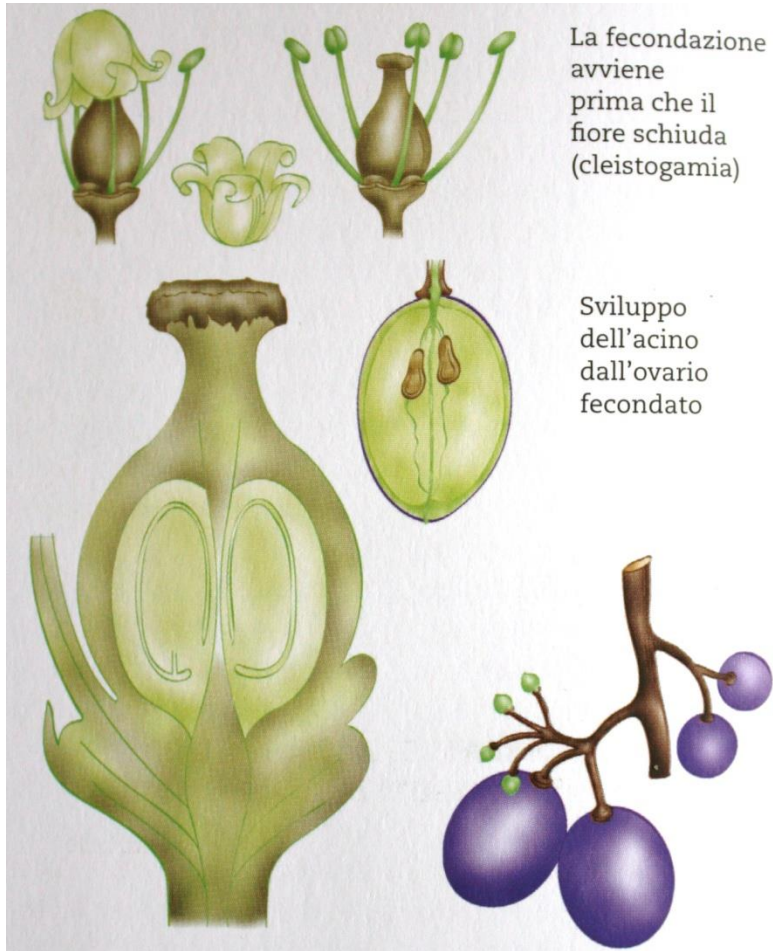



# STADI FENOLOGICI DELLA VITE

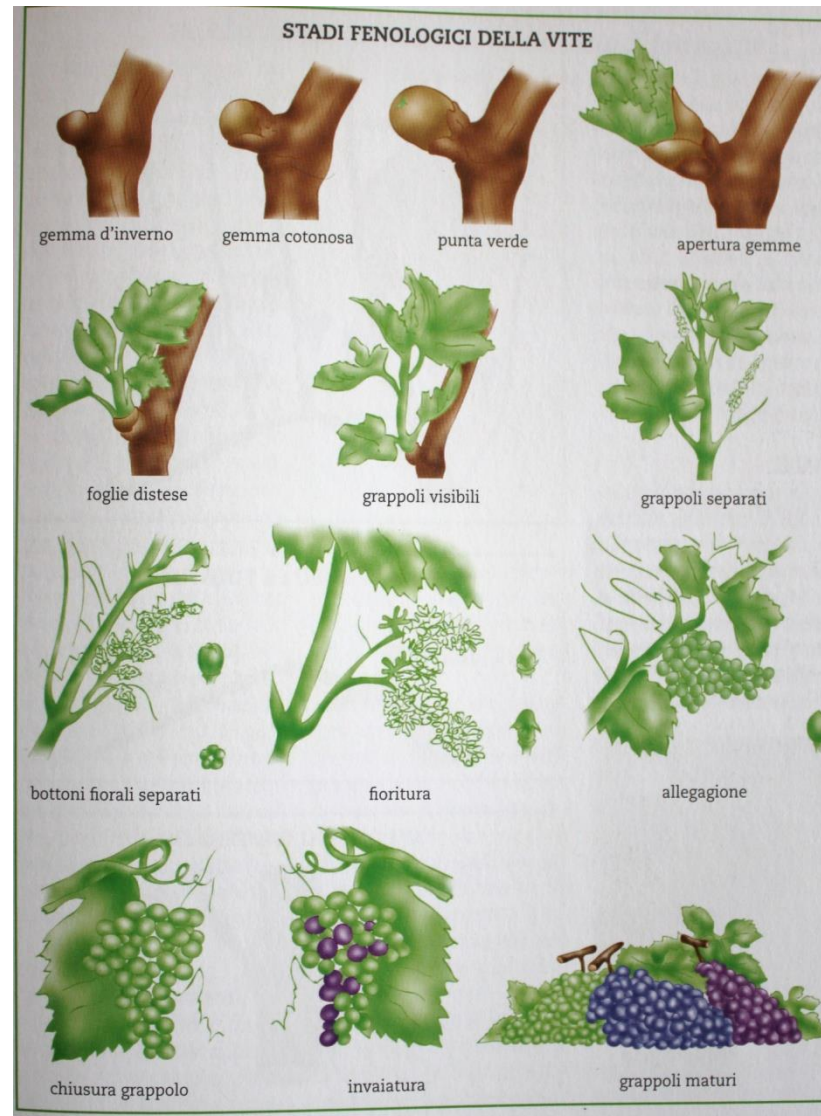

# LA VITE

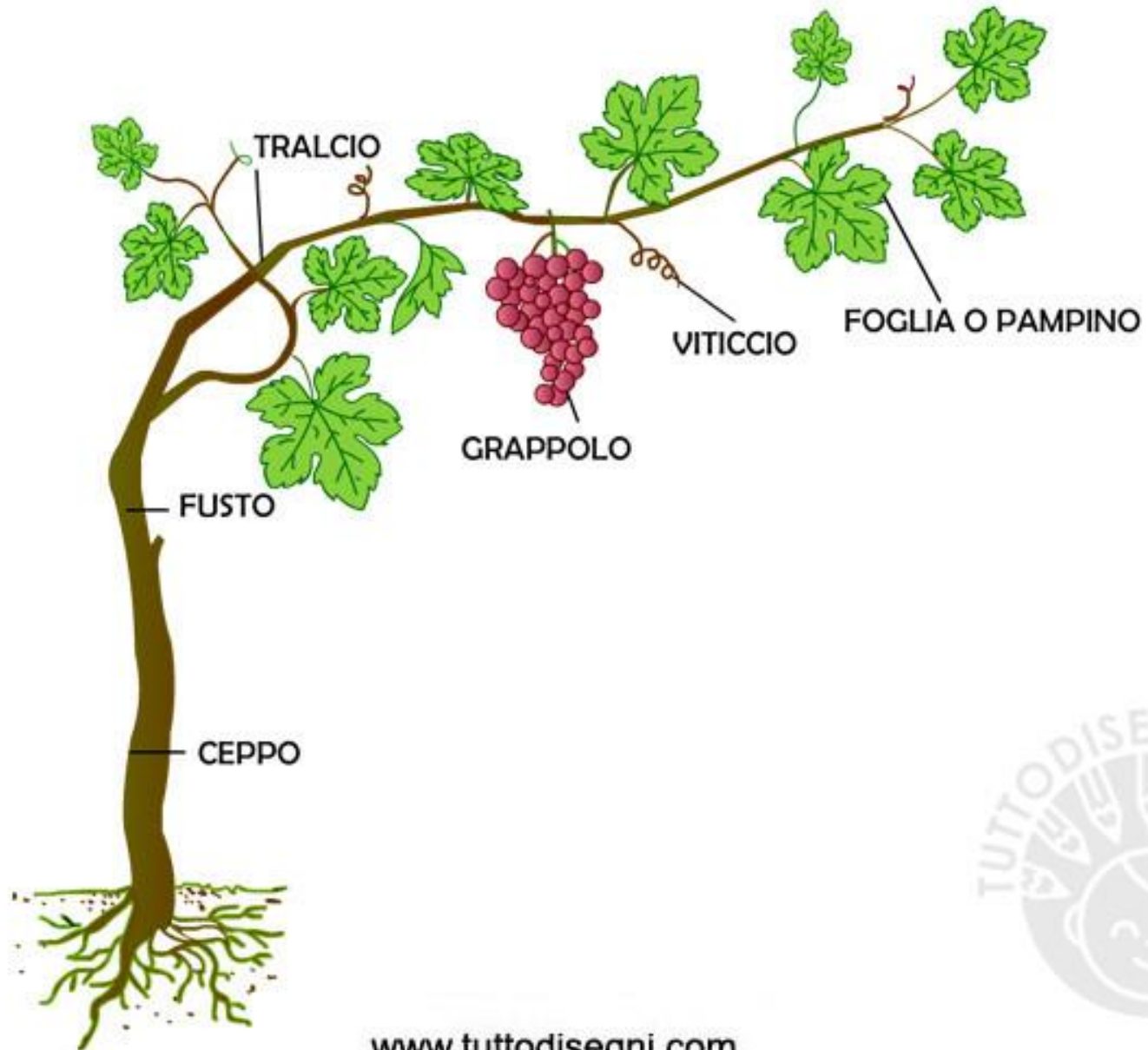

# Le caratteristiche del potatore





# GLI ORGANI DEL TRALCIO

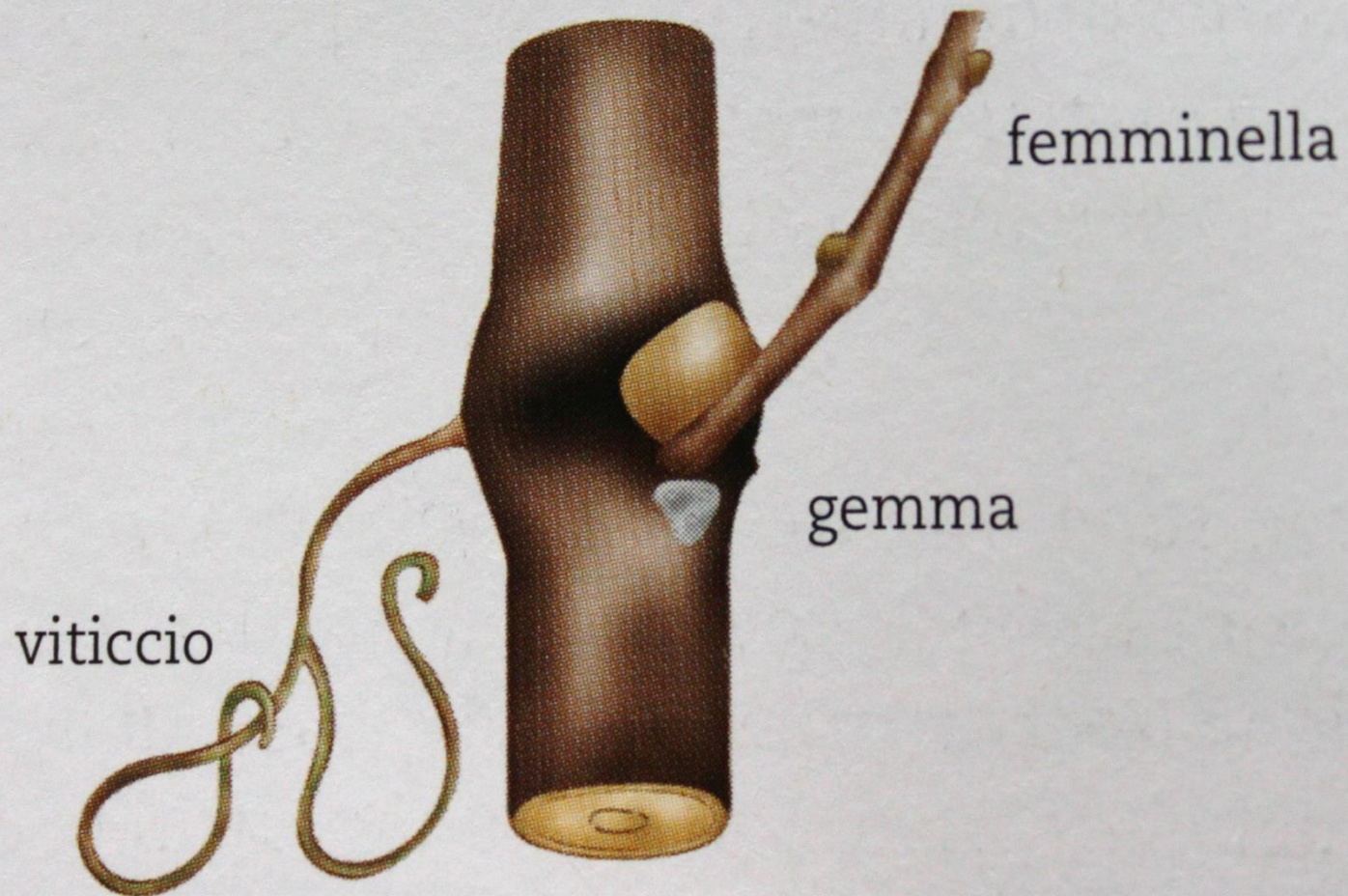

# PIANTA IN VEGETAZIONE





# PIANTA DOPO LA POTATURA

sperone



tralcio



# GUYOT SEMPLICE

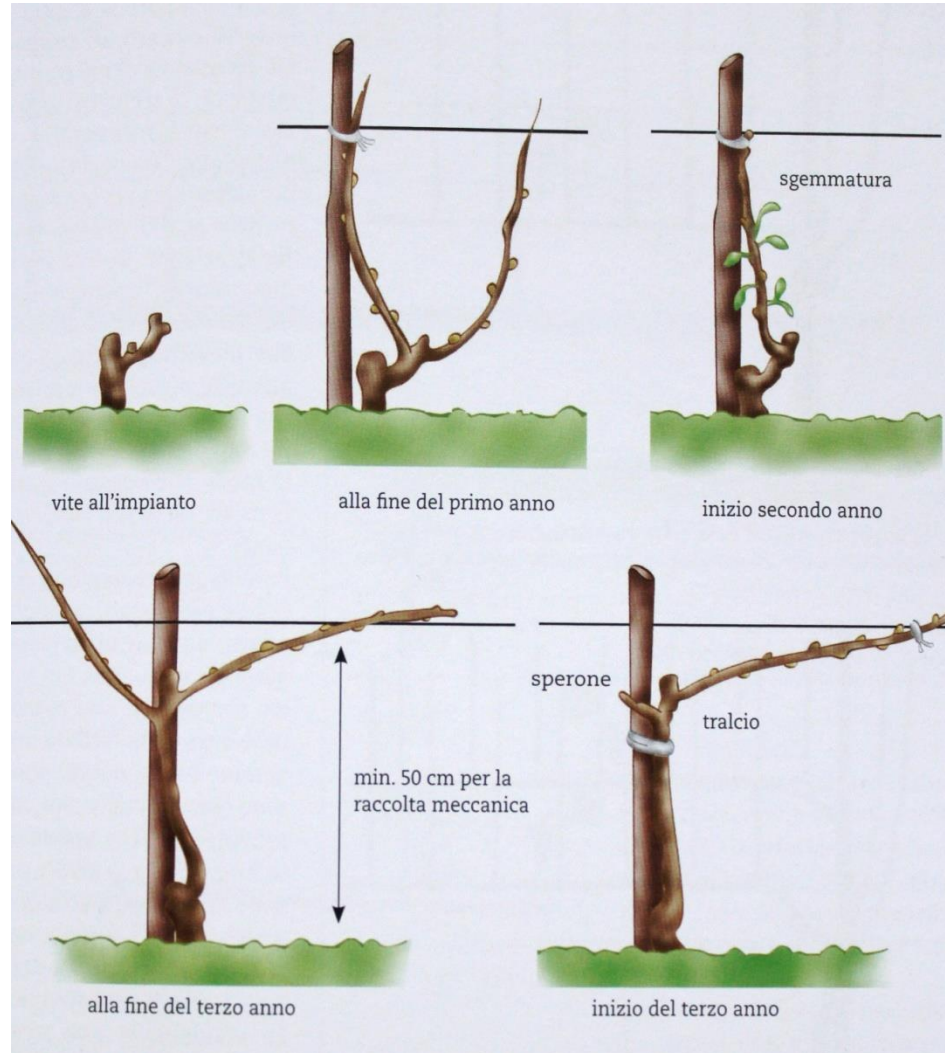

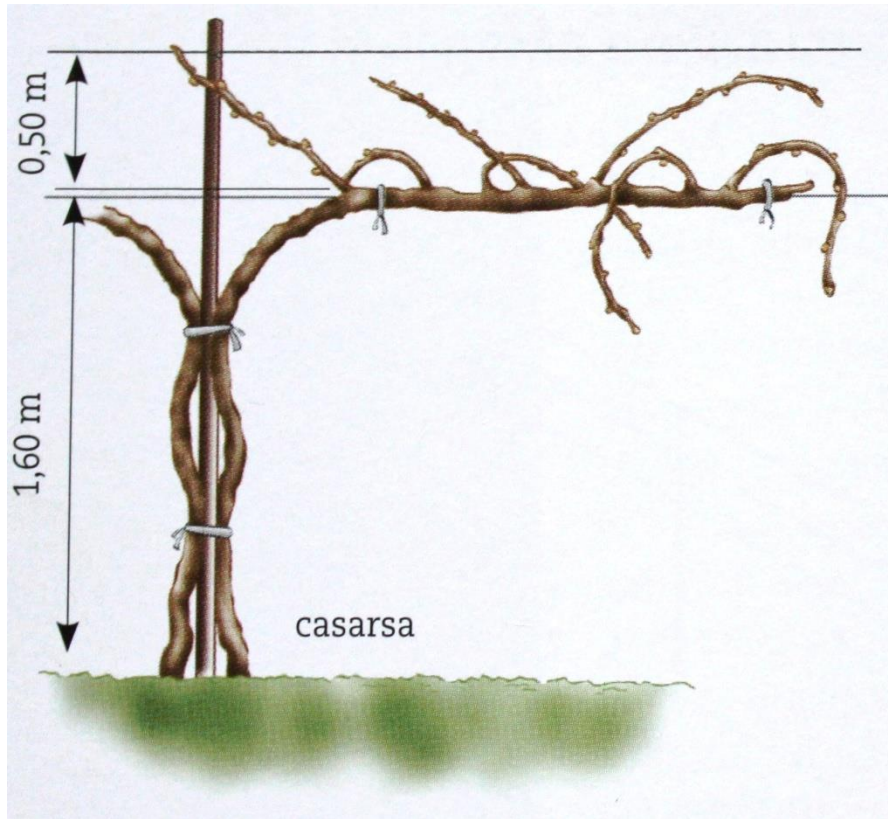

casarsa

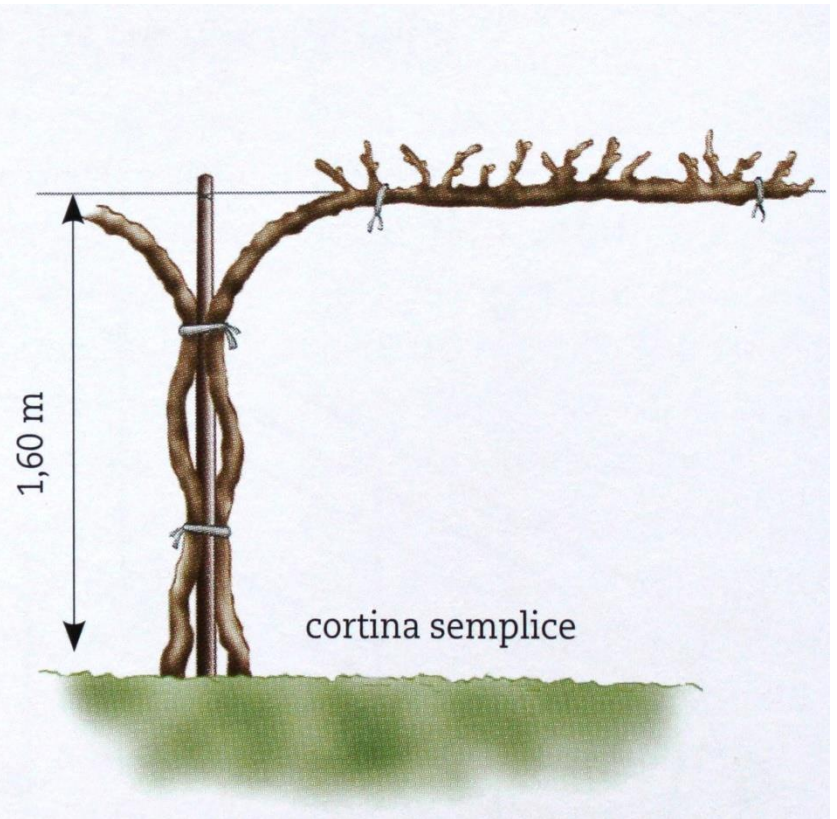

cortina semplice



# GDC

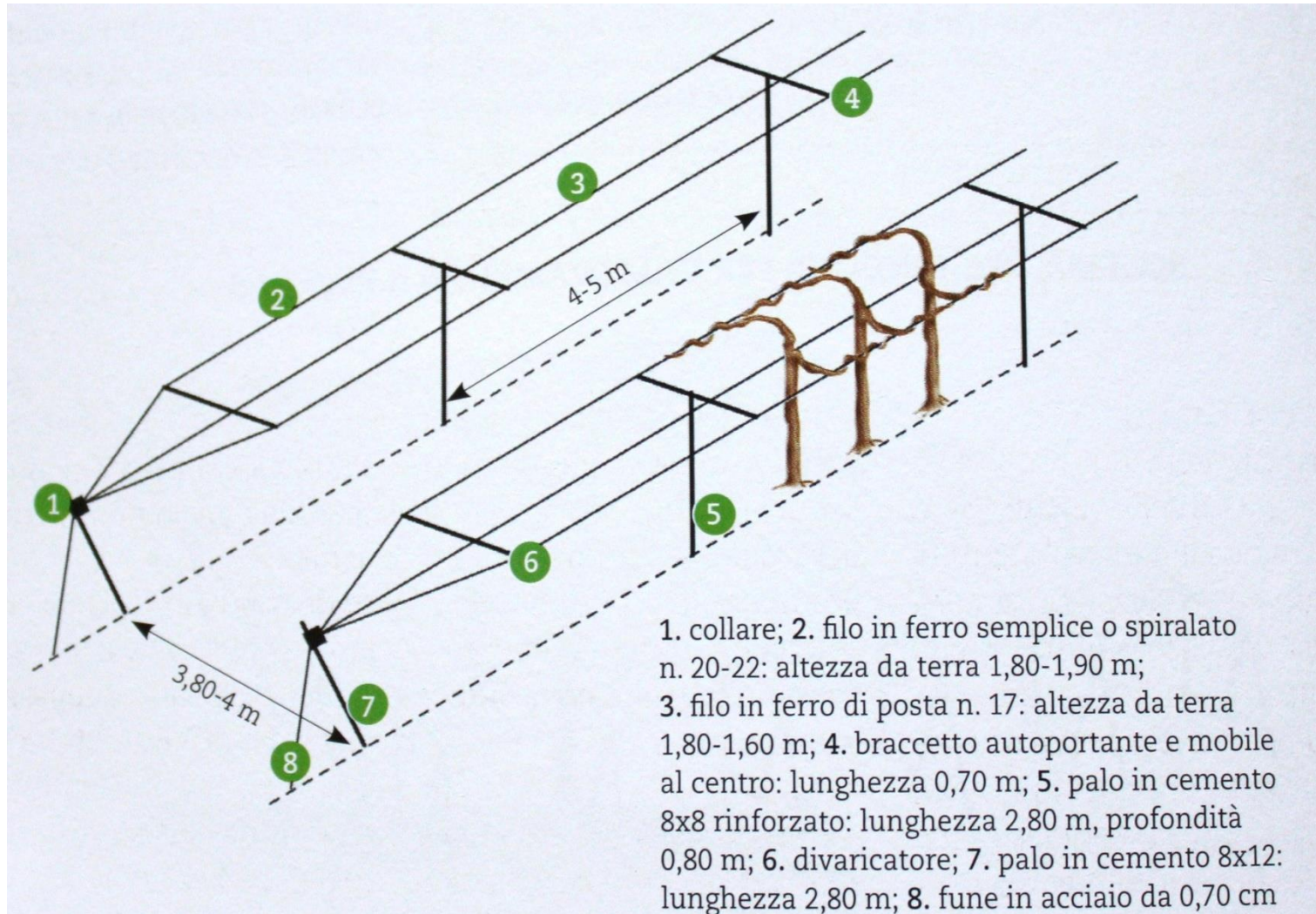



# POTATURA GUYOT NEL RISPETTO DEI FLUSSI LINFATICI



# GUYOT IN VEGETAZIONE

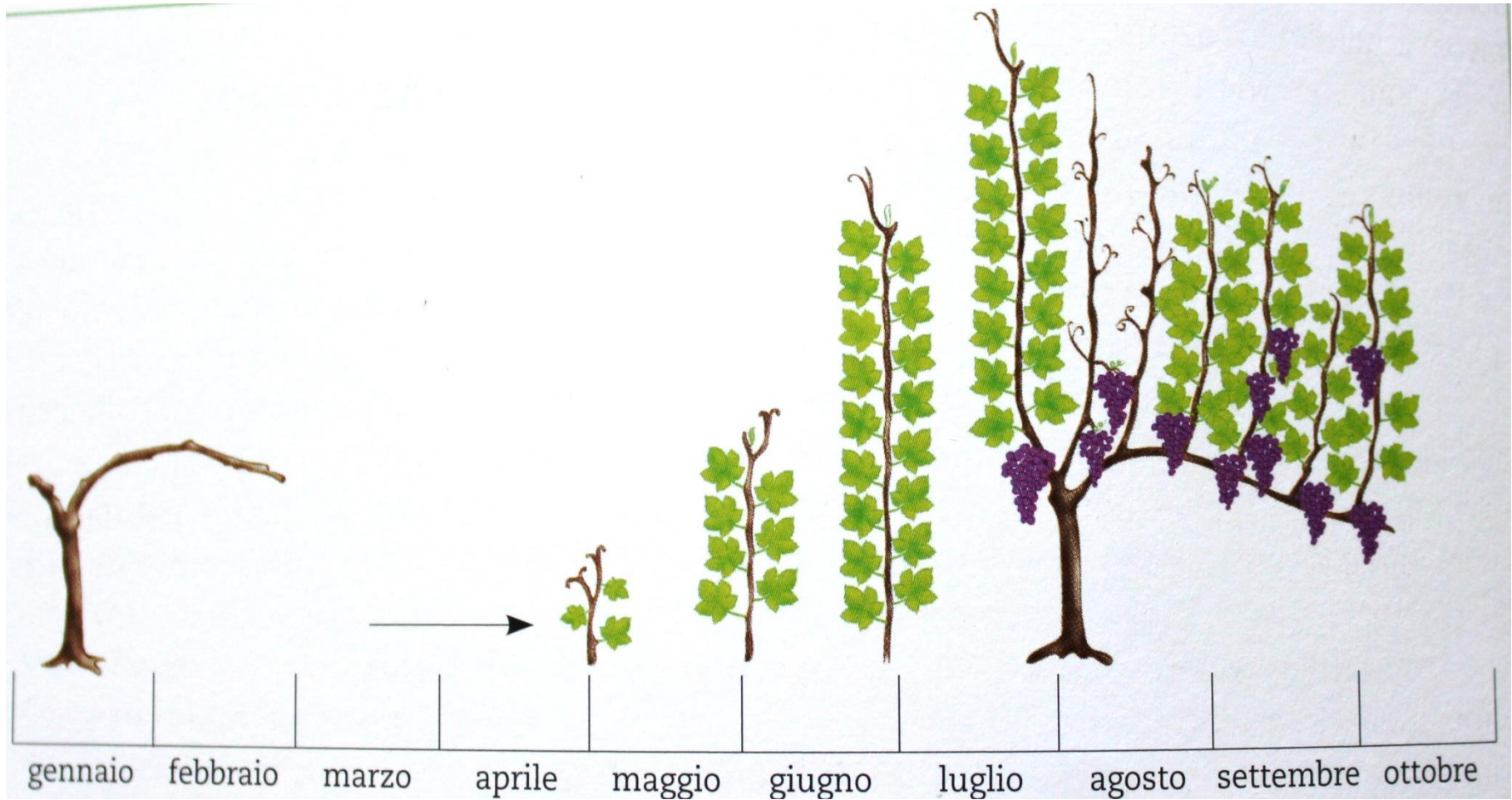

# PERGOLA

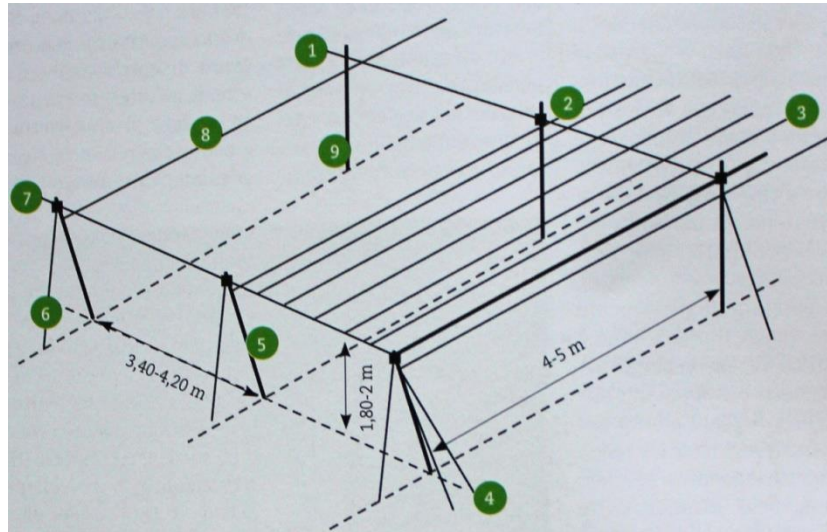

1. fune in acciaio da 6 mm; 2. collare; 3. filo in ferro n. 17 (acciaio/crapal corrispondenti);  
4. ancoraggi con asta; 5. palo 8x12: lunghezza 3,20 cm; 6. fune in acciaio da 7 mm;  
7. fune in acciaio da 12 mm; 8. filo testa n. 18; 9. palo 7x7: lunghezza 2,80 m

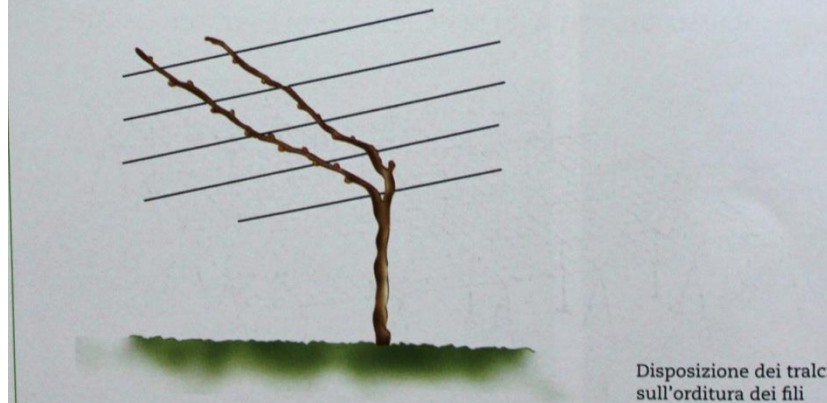

Disposizione dei tralci  
sull'orditura dei fili



# IMMAGINE DI PERGOLA(BERSOT)



LA PERGOLA è PARTICOLARMENTE ADATTA PER VECCHI VITIGNI EMILIANI  
COME: TREBBIANO, MONTUNI, PIGNOLETTO, ALIONZA E ALBANA.

## GUYOT SEMPLICE

## GUYOT DOPPIO

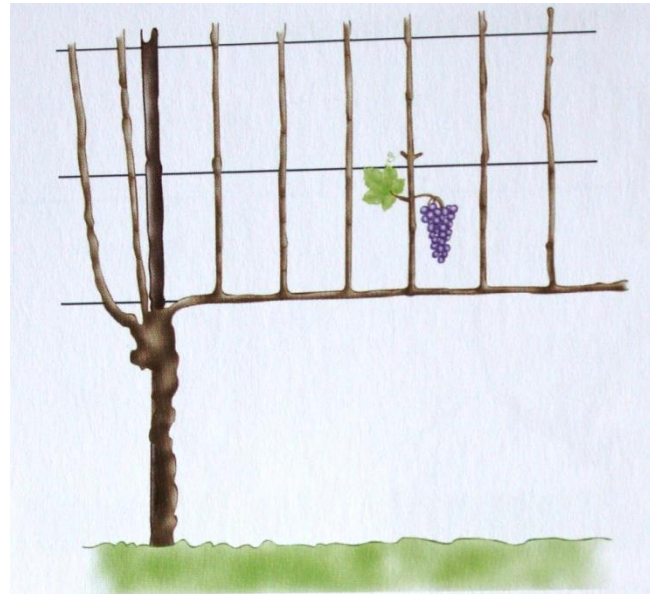

Sul guyot classico si deve prelevare la foglia opposta al grappolo basale del germoglio intermedio del capo a frutto

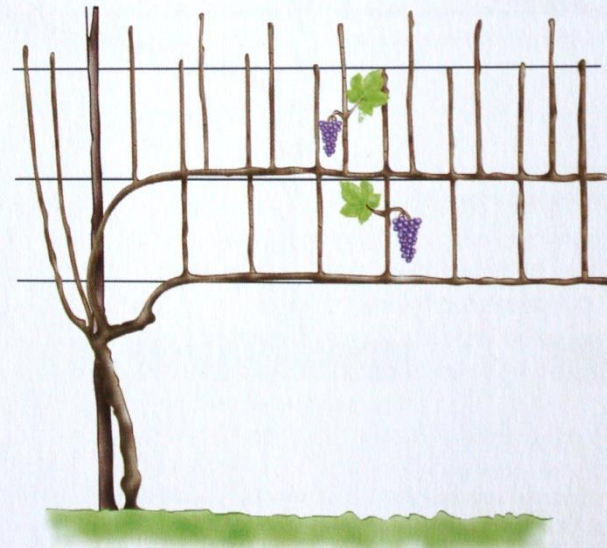

Sul guyot doppio sovrapposto (o bilaterale) si devono prelevare le foglie sui due tralci a frutto, sempre dai germogli intermedi



## GUYOT PRIMA E DOPO LA POTATURA INVERNALE

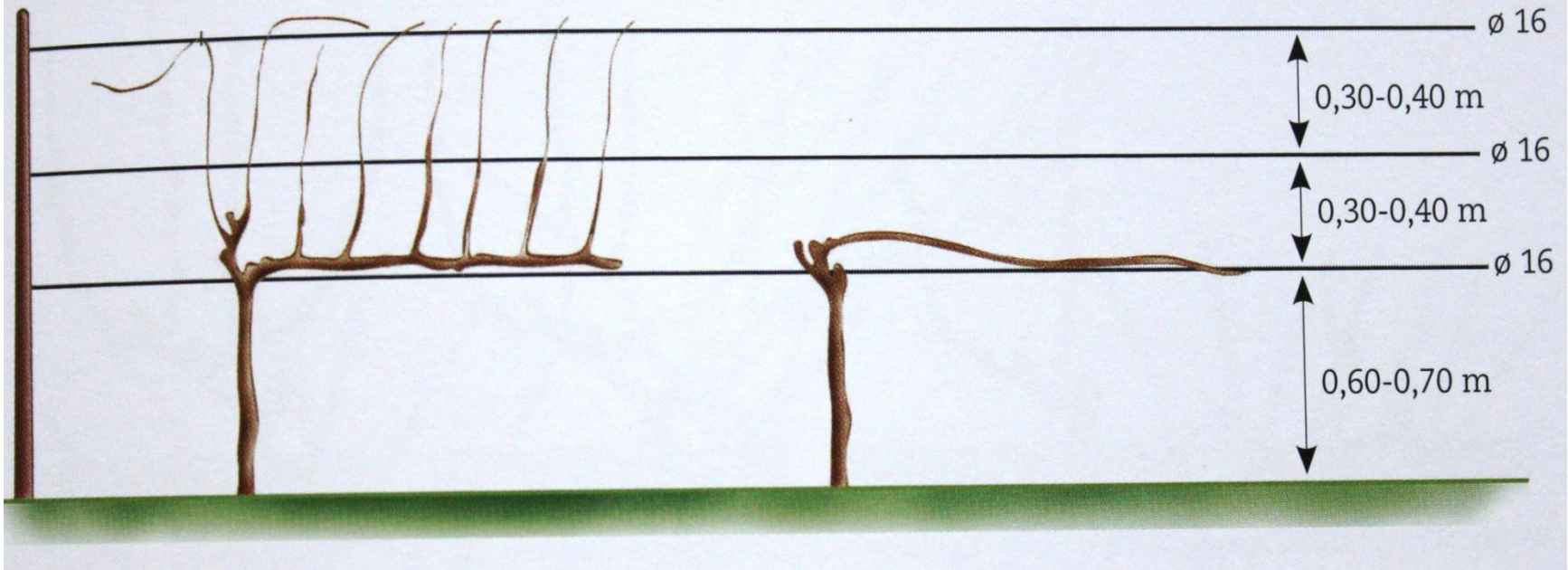



## CORDONE SPERONATO PRIMA E DOPO LA POTATURA



(fonte: Ricci,  
1968)

Il diametro dei fili è indicato con il numero tradizionale per quelli zincati e con il diametro (tra parentesi) per quelli in acciaio

# CORDONE SPERONATO

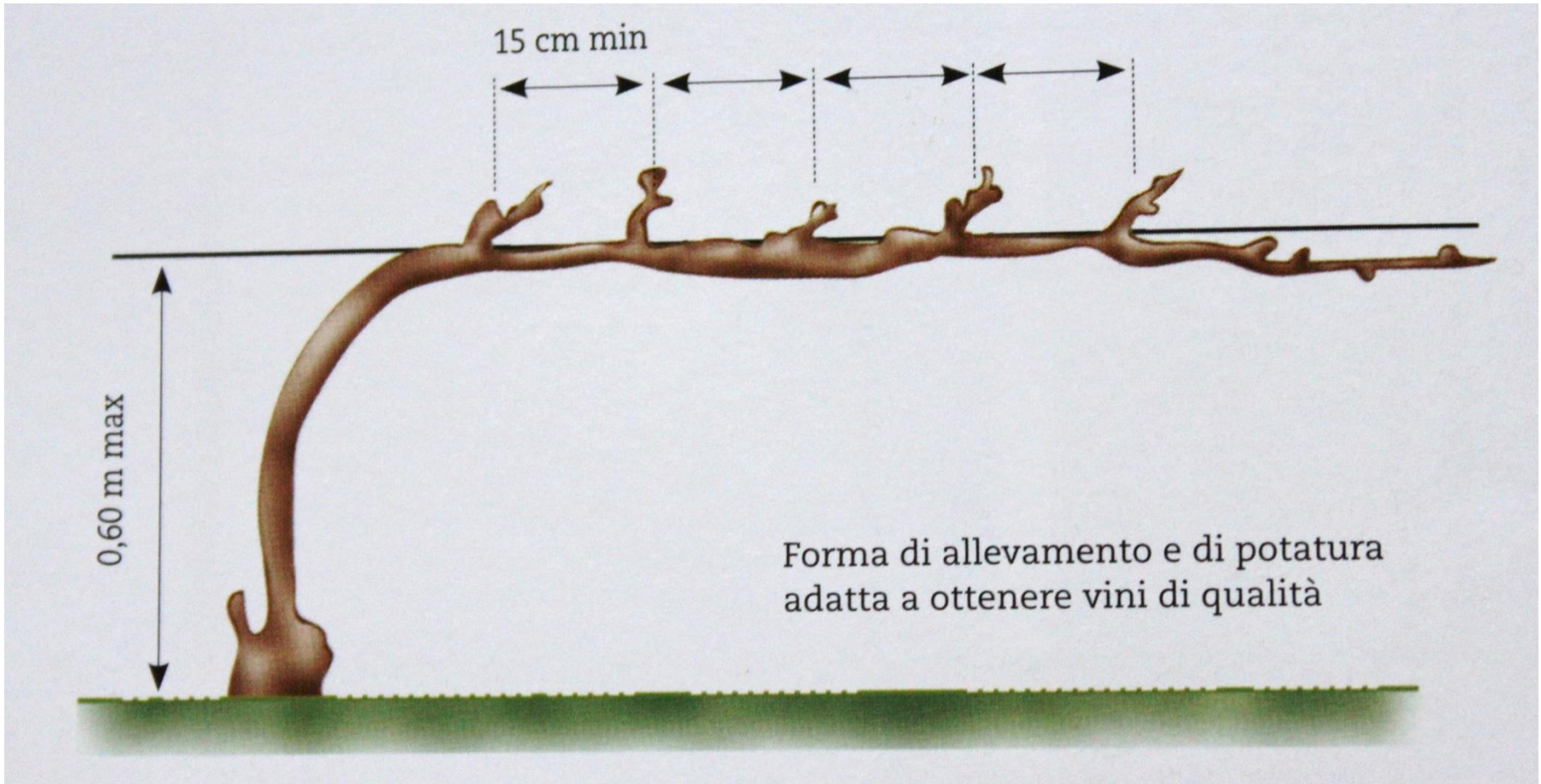



# CORDONE SPERONATO DI CHARDONNAY





# SPERONI



taglio corretto



taglio errato



Nella potatura a sperone, sia nell'alberello sia nel cordone speronato, si può facilmente incorrere in errori (speroni troppo lunghi) che allontanano progressivamente la produzione dal ceppo

## POTATURA DEL CORDONE

- 1) FORMARE GLI SPERONI CON TRALCI BEN LIGNIFICATI
- 2) SPERONI INSERITI, **QUANDO POSSIBILE**, SU LEGNO DI 1-2 ANNI E **VERTICALI**
- 3) EVITARE I TAGLI RADENTI CHE ASPORTANO LE GEMME BASALI
- 4) LASCIARE 2 GEMME VISIBILI





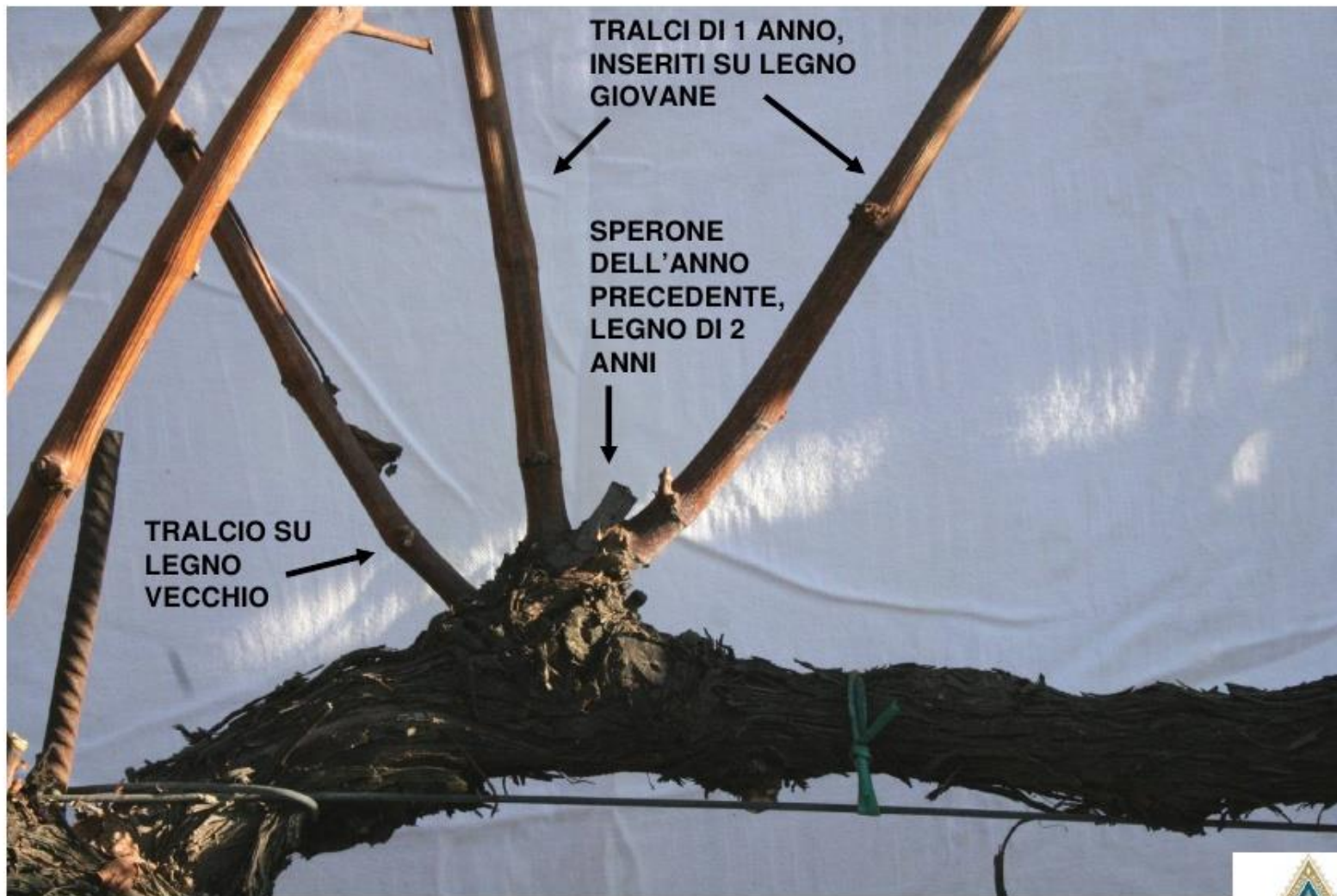



## GLI ERRORI PIÙ COMUNI

NO,  
SPERONE INSERITO SU LEGNO DI OLTRE 2  
ANNI

NO,  
I GROSSI TAGLI CAUSANO  
FERITE



Muratori  
VELUTATE E AFFIDABILITÀ IN OGNI PROGETTO

## SCELTA DELLO SPERONE

SPERONE SU  
LEGNO VECCHIO

SPERONE SU  
LEGNO GIOVANE

POTATURA ULTIMATA



ASSOCIAZIONE MURATORI ITALIANA  
**Muratori**  
VELUTATE E AFFIDABILITÀ IN TUTTE LE OPERAZIONI

## TAGLIO CORRETTO

SI,  
SPERONE SUL LEGNO  
DI 1 O 2 ANNI

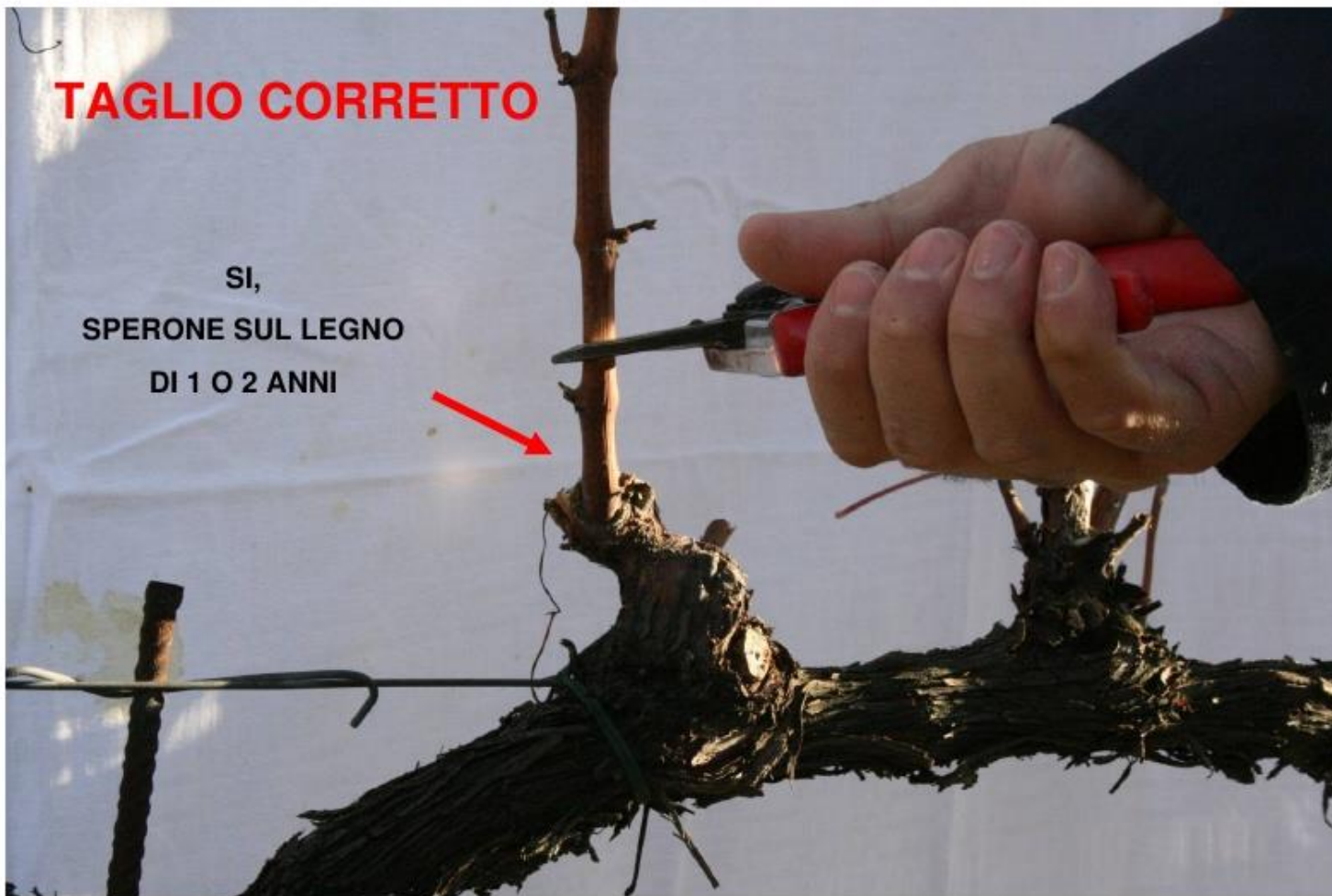

Muratori  
VELUTATI E VITICULTORI DELLA PUGLIA



**TAGLIO DEL LEGNO DA ASPORTARE  
ATTENZIONE ALLA PROFONDITÀ DEL TAGLIO**



**SI,  
SENZA ASPORTAZIONE DELLE  
GEMME DELLA CORONA**



**NO,  
ASPORTAZIONE DELLE GEMME  
DELLA CORONA E QUINDI PERDITA  
DI PUNTI VEGETATIVI FUTURI**



**Muratori**  
VELUZIONI E AFFIDAMENTO PER IL LEGNO

## TAGLIO DEL RINNOVO

SI,  
GEMMA RIVOLTA VERSO L'ALTO



NO,  
GEMMA RIVOLTA VERSO IL BASSO. LA  
VEGETAZIONE CRESCERÀ PENDENTE



## ESEMPIO DI RINNOVO IN CASO DI CORDONE SVUOTATO

NO A TAGLI TROPPO  
RADENTI





**PIANTA GIOVANE:  
RINNOVO CON I 3 PUNTI DI  
LEGATURA**



# FLUSSO LINFATICO NEL CANALE



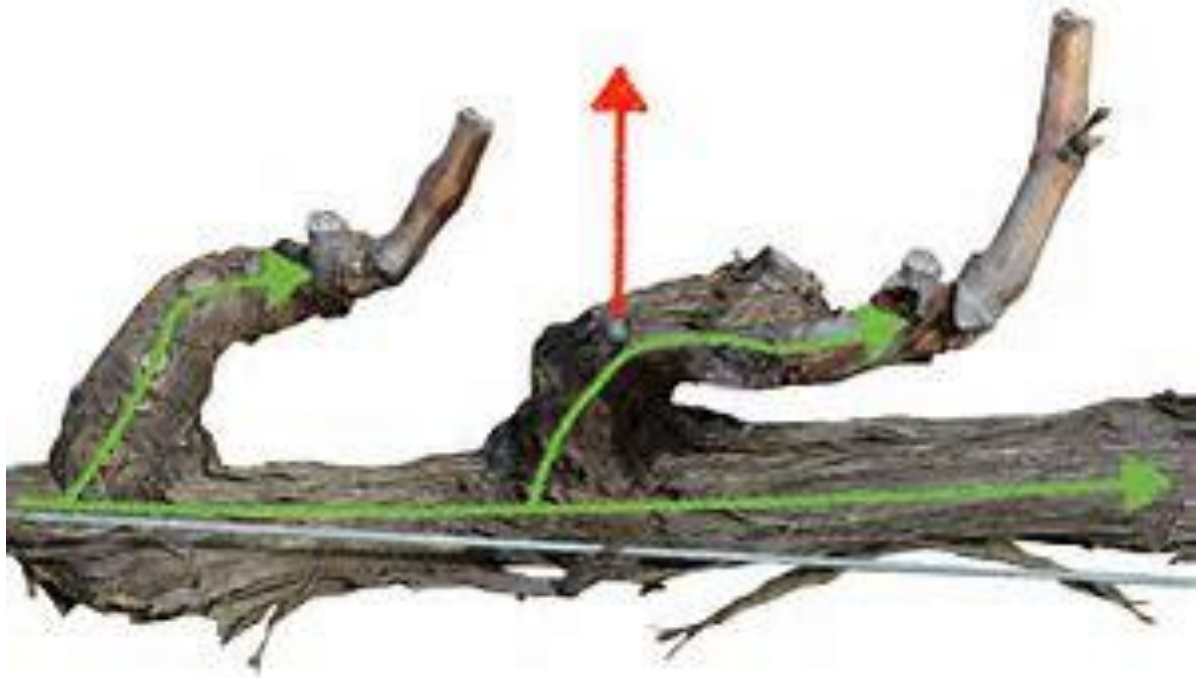



# TAGLIO DI RITORNO O DI FORMAZIONE



# ESEMPIO POTATURA A GUYOT

Come si presenta la vite prima della potatura













# TAGLIO DEL PASSATO













# TAGLIO DEL FUTURO









# TAGLIO DEL PRESENTE













# ELIMINAZIONE TRALCI SUPERFLUI









# COME SI PRESENTA LA VITE DOPO LA POTATURA





# PRIMA E DOPO LA POTATURA









# PRE POTATURA MECCANICA CON FINITURA MANUALE





# POTATURA VERDE E SPOLLONATURA



# STRUTTURA PER VIGNETO

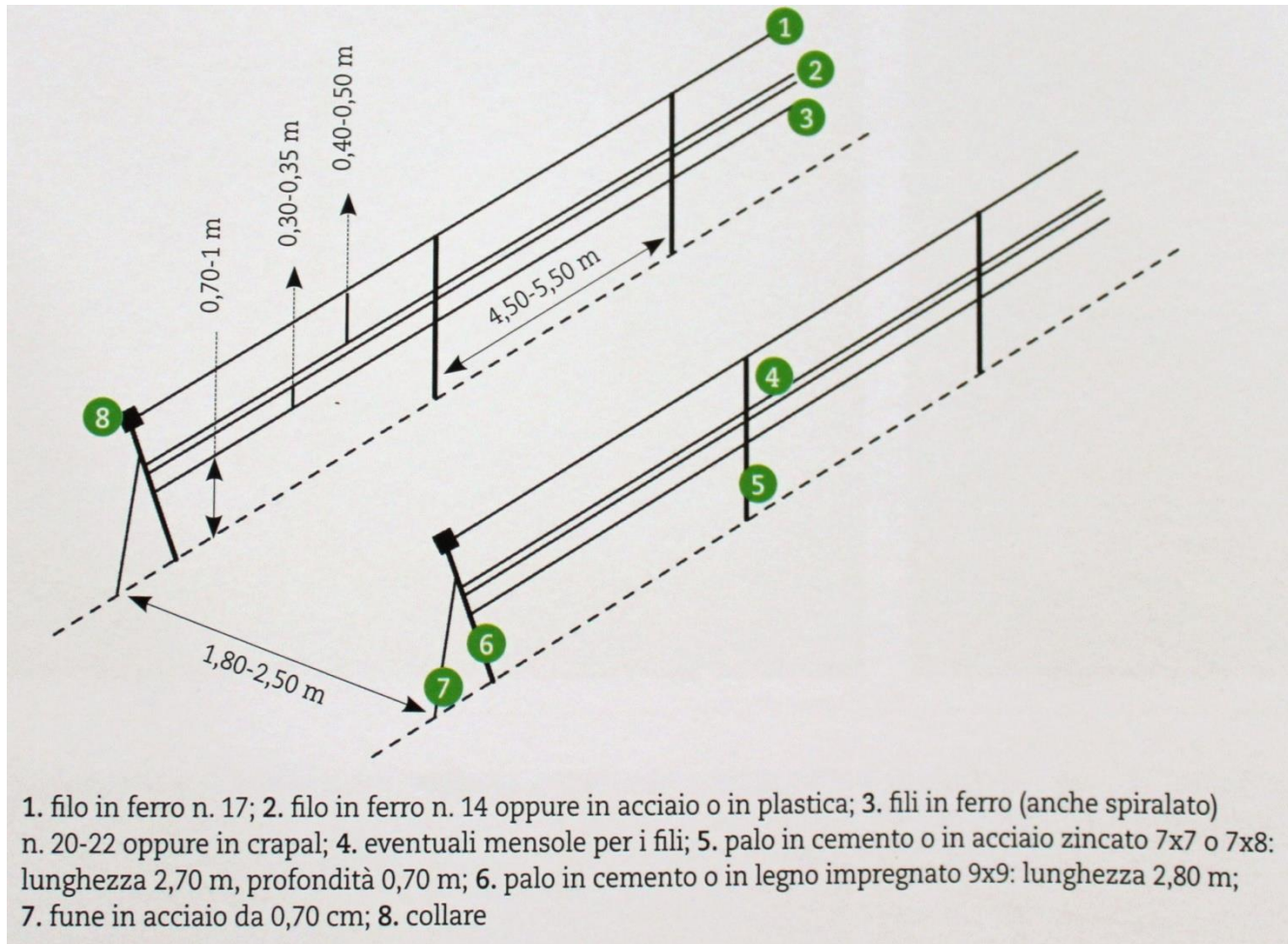



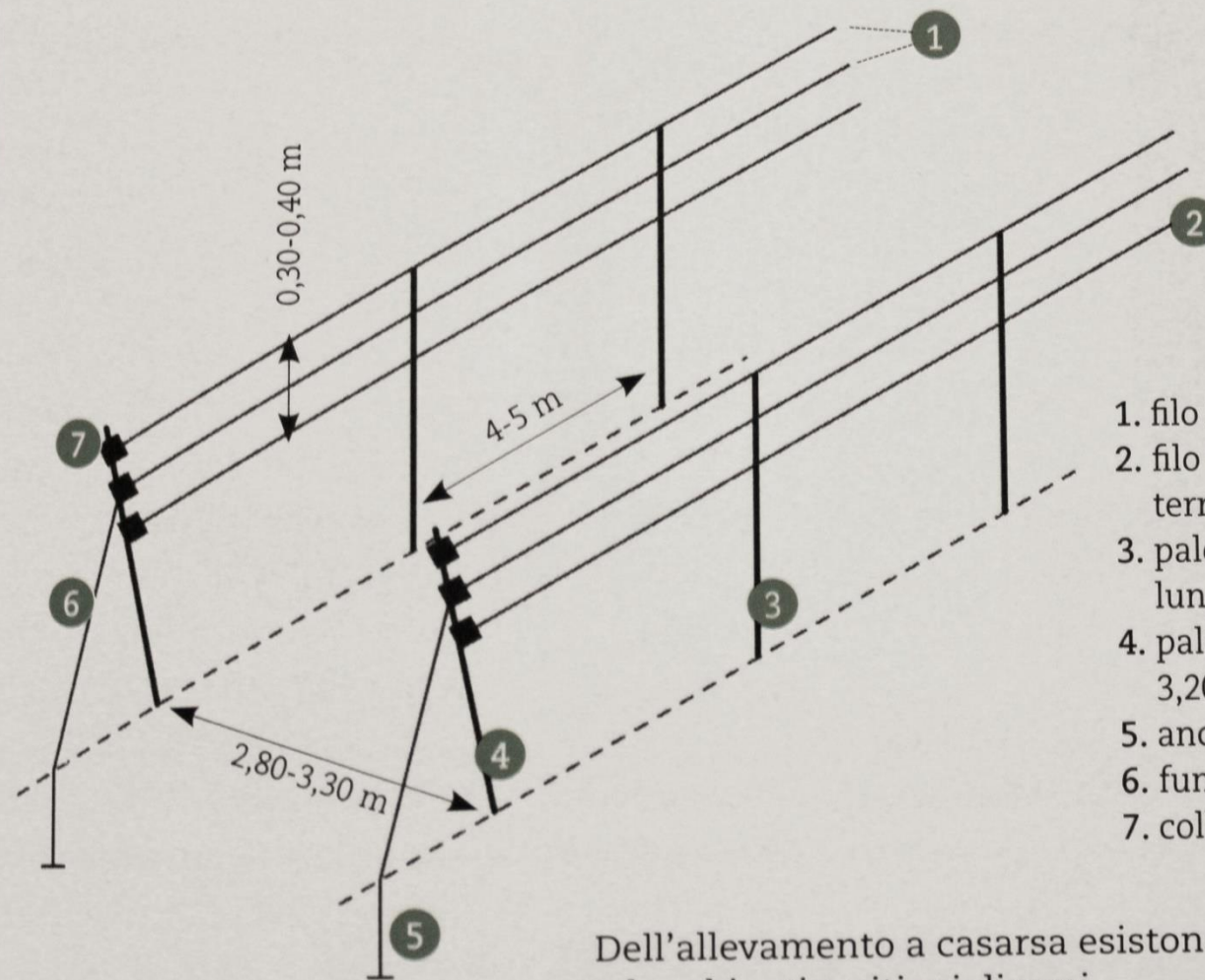

1. filo in ferro n. 16-17
2. filo in ferro n. 20-22: altezza da terra 1,60-1,80 m
3. palo in cemento 8x8 o 7x8: lunghezza 3 m, profondità 0,70 m
4. palo in cemento 9x9: lunghezza 3,20 m
5. ancora con asta
6. fune in acciaio da 0,70 cm
7. collare

Dell'allevamento a casarsa esistono molte versioni adattate ad ambienti e vitigni diversi

# ALBERELLO

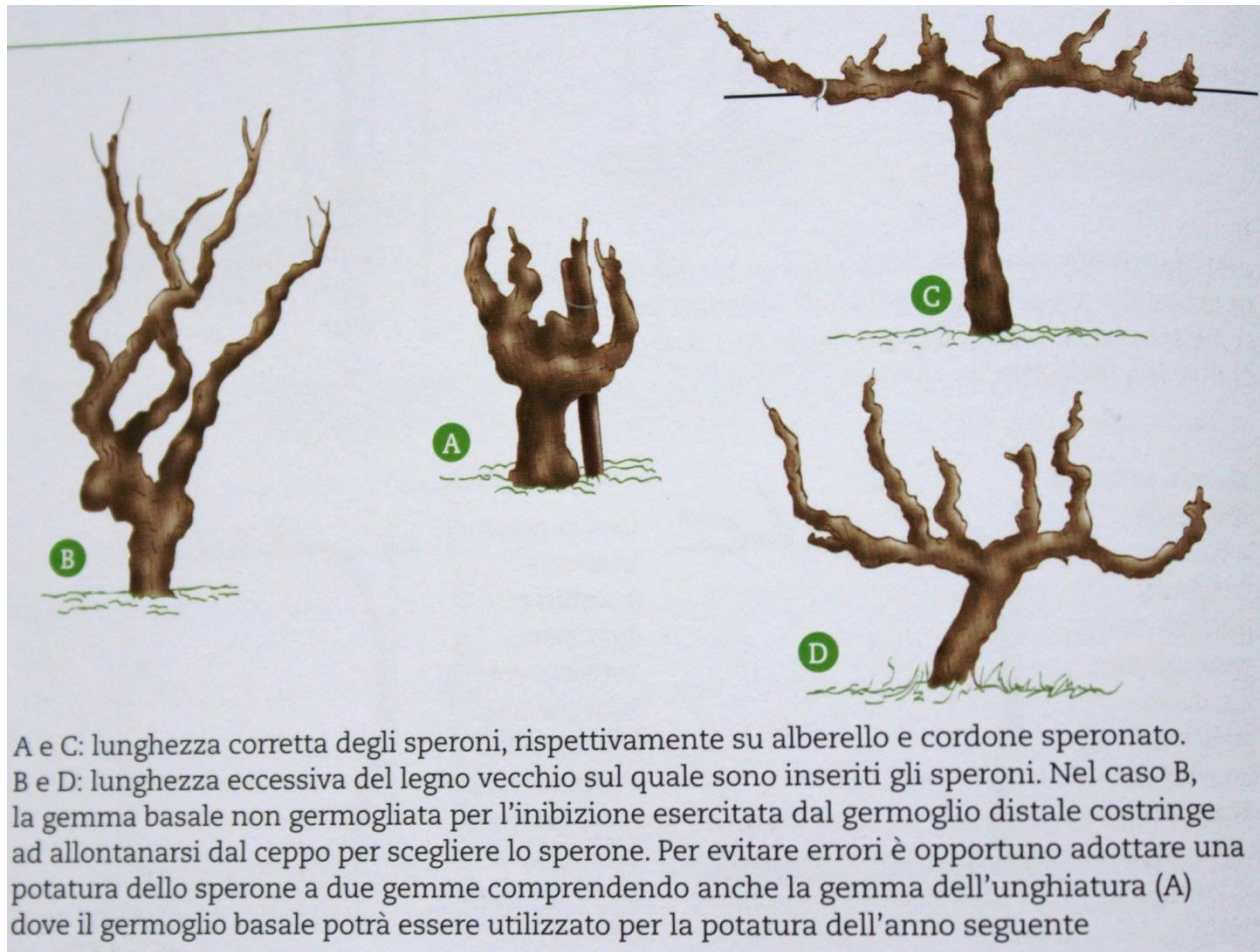



# DUE TIPI DI PERGOLA

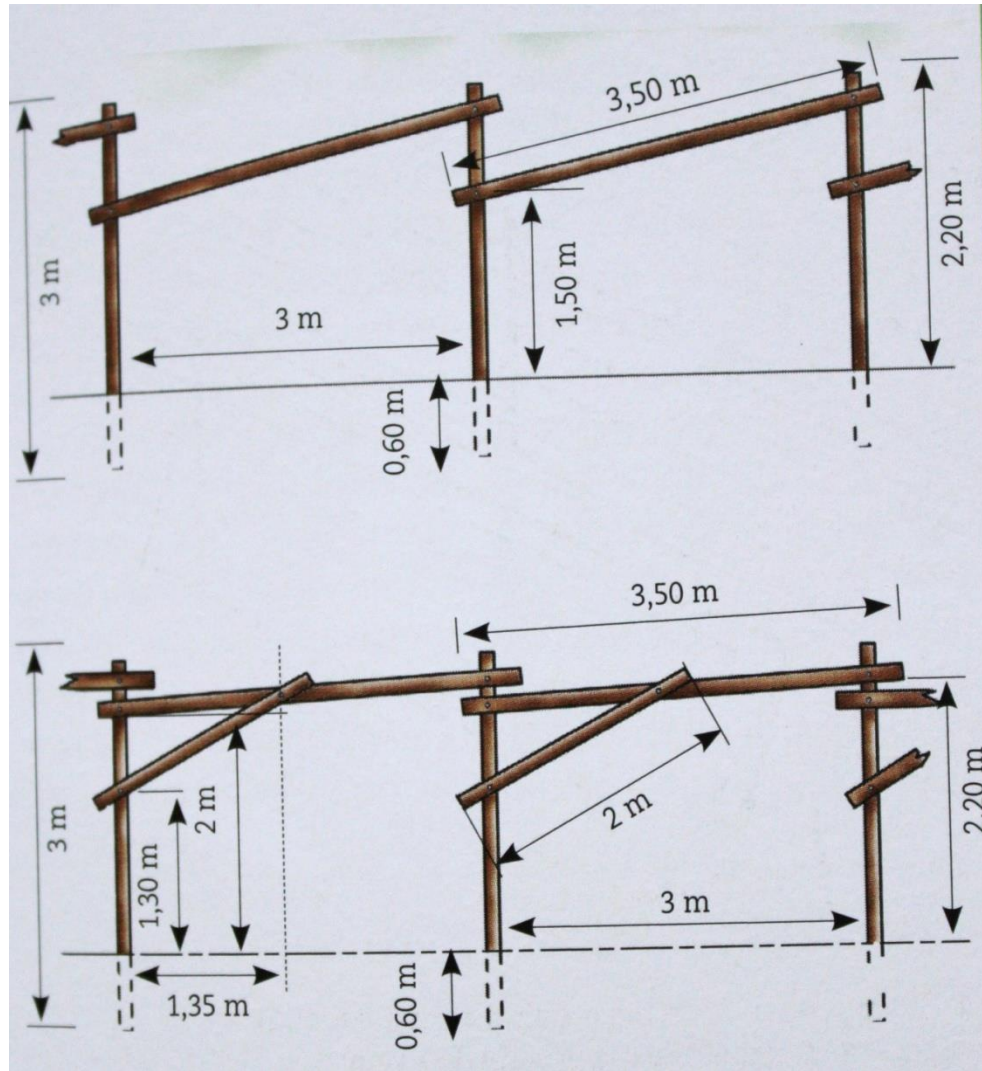

# DENDROCHIRURGIA SU MAL DELL'ESCA





# FLAVESCENZA DORATA



## TIPOLOGIE DI INNESTO

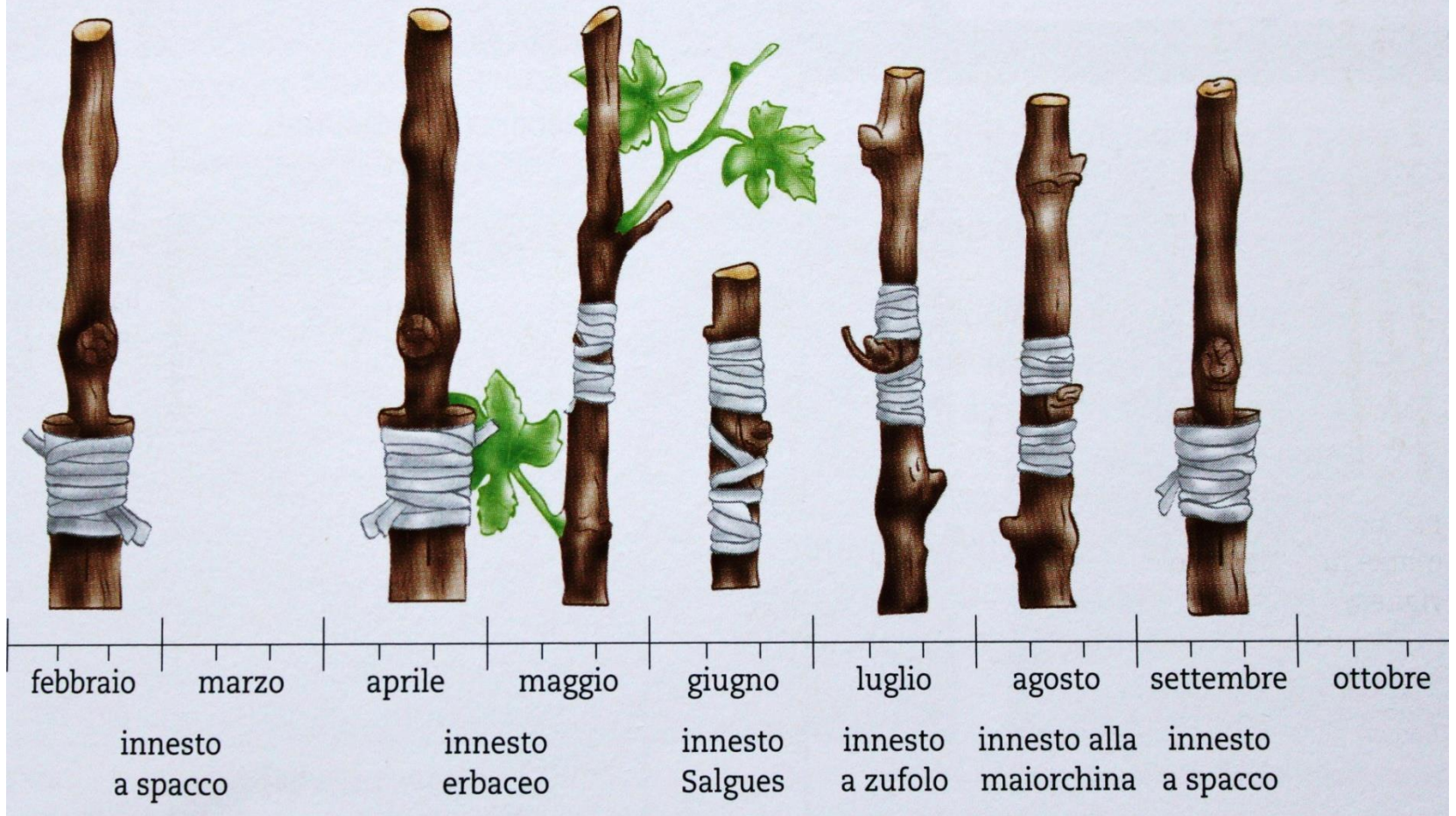



# INNESTO A SPACCO



Inserimento delle marze nello spacco del tronco e legatura



Il tutto viene avvolto con un foglio di materiale plastico riempito con sabbia umida

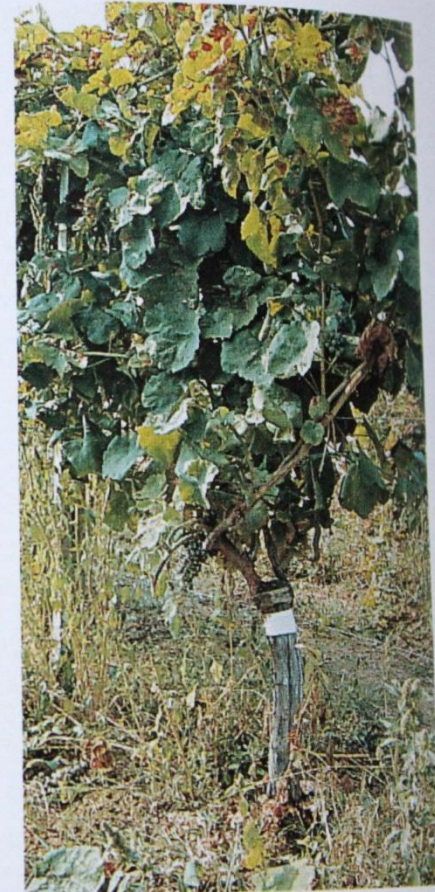

La vite innestata dopo un anno







# PRODUZIONE DI BARBATELLE INNESTATE

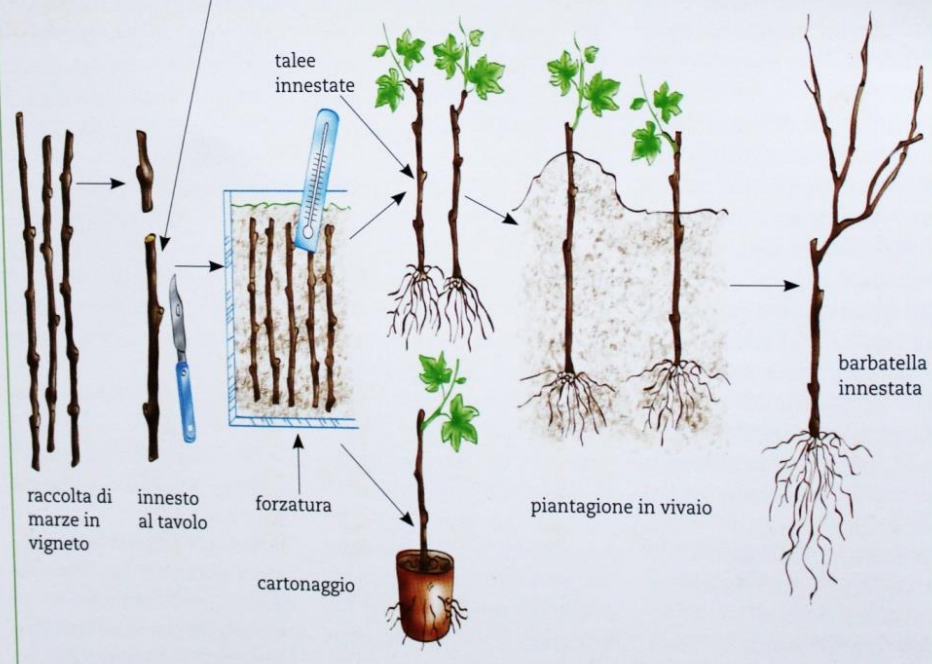
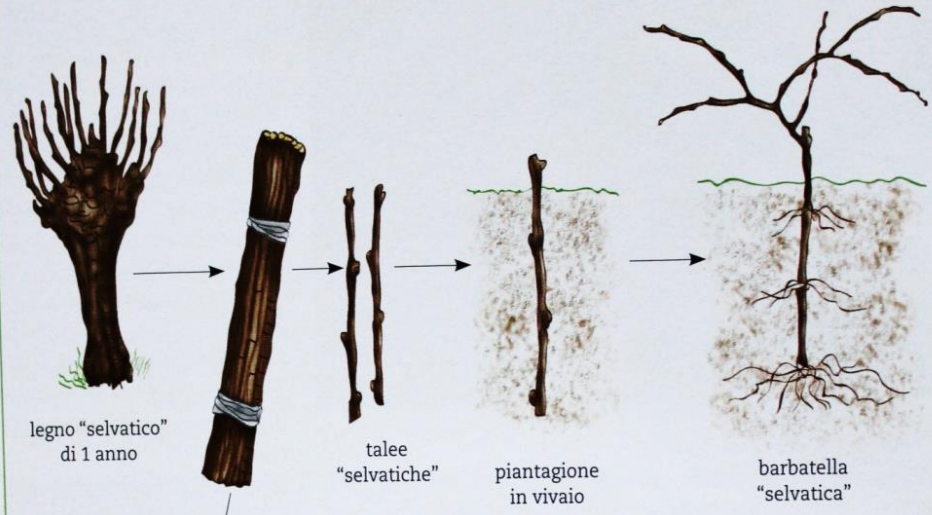

# VENDEMMIATRICE





# FORME DI ALLEVAMENTO DELLA VITE



